





















Maniglia porte passeggeri - Passengers' door handle





P.216

-  **Materiale - Material**
Poliammide fibra vetro + anti-UV
Glass fibre polyamide + anti-UV
-  **Colore - Colour**
secondo codice - according to item code
-  **Pezzi confezione - Package items**
20 pezzi - pieces
-  **Volume confezione - Package volume**
7,0 dm³
-  **Peso confezione - Package weight**
2.800 g
-  **Ricambi - Spare parts**
vedi sez. tecnica - see technical section
-  **Accessori - Accessories**
vedi sez. tecnica - see technical section
-  **Carico di rottura - Breakup load**
-
-  **Temp. di esercizio - Working temp.**
-10/+120 °C
-  **Normative - Norms**
pag. A4



P.216		m manual				
	Cod.	Nero - Black	Rosso - Red			
A1 - 137	60768	•		•		
	66721		•			• 500
A2 - 146	66967	•				• 500
A3 - 150	60688	•				• 500
A4 - 124	60698	•				• 500
A5 - 501	60708	•				• 500
A6 - 502	60718	•				• 500
A7 - 250	60728	•				• 500
A8 - 262	60738	•				• 500
A9 - 269	60748	•				• 500
A10 - 278	60758	•				• 500
A11 - 156	63821	•				• 500
A12 - 142	63831	•				• 500
A13 - 503	63841	•				• 500
A14 - 504	63851	•				• 500
A15 - 505	63861	•				• 500
A16 - 506	63871	•				• 500
A17 - 507	63881	•				• 500
A18 - 508	63891	•				• 500
A19 - 509	63901	•				• 500
A20 - 516	63511	•				• 500

P.216		m manual				
	Cod.	Nero - Black	Rosso - Red			
A21 - 511	63911	•				• 500
A22 - 512	63491	•				• 500
A23 - 513	60811	•				• 500
A24 - 514	63921	•				• 500
A25 - 515	62281	•				• 500
A26 - 516	63041	•				• 500
A27 - 517	63931	•				• 500
A28 - 518	63941	•				• 500
A29 - 519	63951	•				• 500
A30 - 520	63331	•				• 500
A31/A40		•				
A44 - 149	63631	•				• 500
A46 - 151	64111	•				• 500
	67737	•				•

-  versione con serratura, chiave rimovibile con maniglia chiusa e aperta
version with lock, removable key with both locked and unlocked handle
-  materiale disponibile a stock - material available on stock
-  materiale non disponibile a stock - material not available on stock
-  lotto minimo d'acquisto - minimum purchasing lot
- versione a richiesta - version available on request

P.216

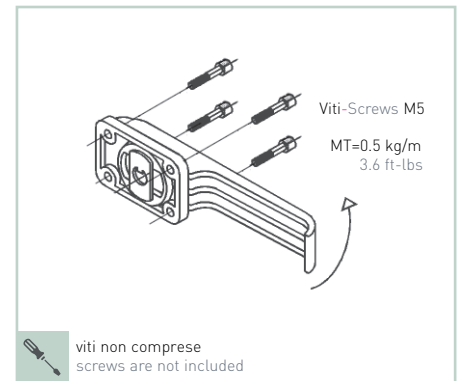
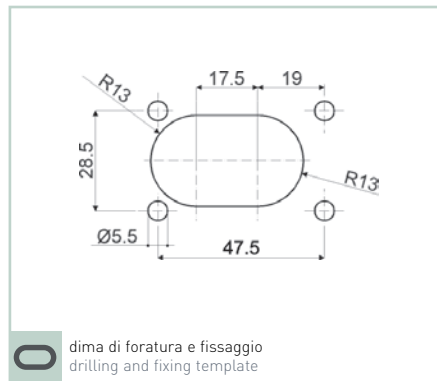
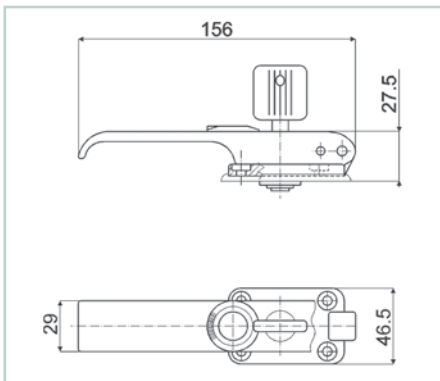

A

■ Esempi d'applicazione - Examples of application

Da utilizzare in abbinamento con le serrandole P.214 - Sez. B. La P.216 sul lato esterno delle porte di emergenza bus e le P.214 all'interno
To be used together with locking gear P.214 -Sec. B. The handle P.216 on the external side of emergency bus doors and P.214 inside

